



Matching sentences and pictures

Kindergarten Reading Comprehension Worksheet

Draw a line from the sentence to the matching picture.

The balloon floats
up into the air.



The dog plays catch
with a stick.



The car has a loud
horn.



The flowers in the
garden are pretty.



The pizza tastes
good.





Matching sentences and pictures

Kindergarten Reading Comprehension Worksheet

Draw a line from the sentence to the matching picture.

The lake is frozen.



The cookies have raisins.



The desert is sandy.



The table seats six people.



The wagon has four wheels.





Matching sentences and pictures

Kindergarten Reading Comprehension Worksheet

Draw a line from the sentence to the matching picture.

The bird chirps.

The rug is on the floor.

The train rolls down the tracks.

The bee lands on a flower.

The campfire keeps us warm.

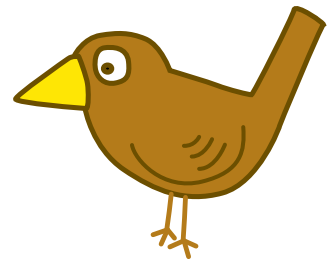
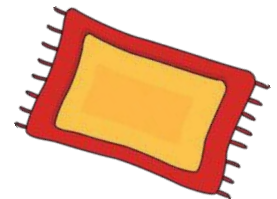



Matching sentences and pictures

Kindergarten Reading Comprehension Worksheet

Draw a line from the sentence to the matching picture.

The apple pie is
yummy.



The square is blue.



The flag is flying.



The sky is cloudy.

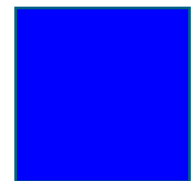

The boy reads a
book.





Understanding sentences

Kindergarten Sentences Worksheet

Read each sentence.

Cut and paste the pictures below the matching sentences.

I see a car.	We ride the bus.	My bike can go.

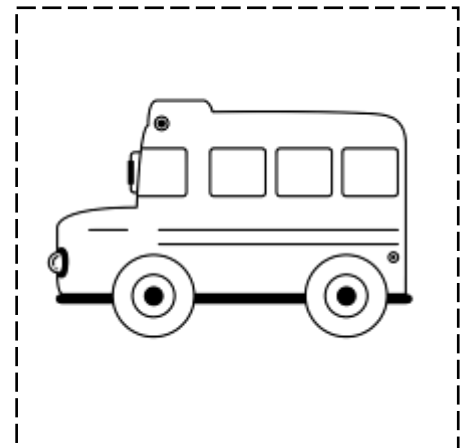
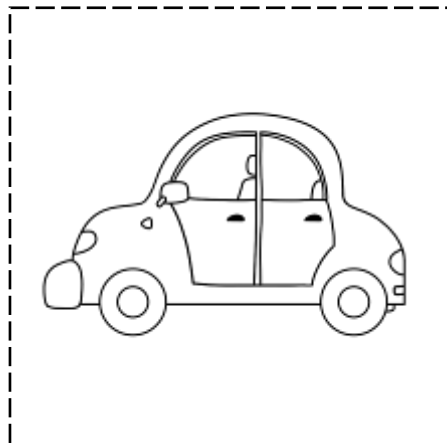
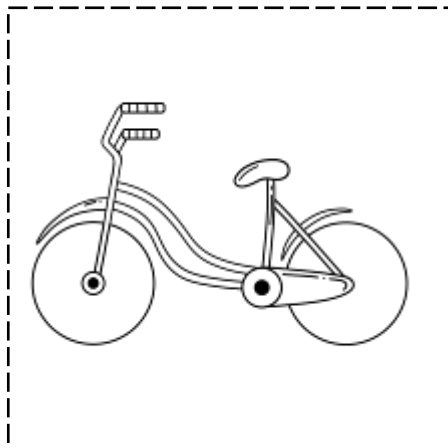



Understanding sentences

Kindergarten Sentences Worksheet

Read each sentence.

Cut and paste the pictures below the matching sentences.

My cat can nap.	The bird can fly.	The dog runs fast.

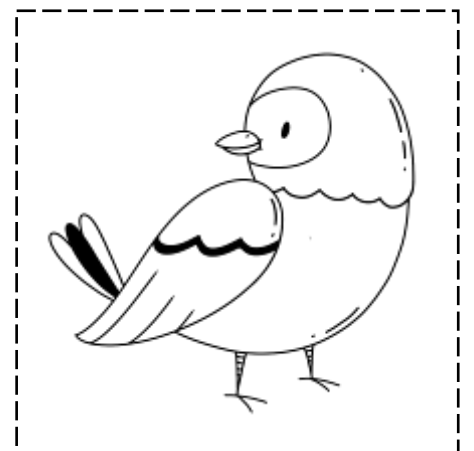
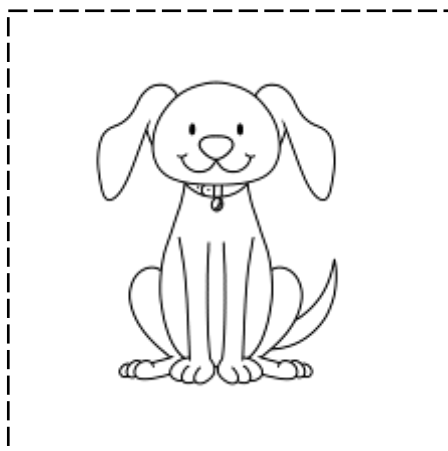



Understanding sentences

Kindergarten Sentences Worksheet

Read each sentence.

Cut and paste the pictures below the matching sentences.

We play in the snow!	The sun feels hot today.	Do you smell the flowers?

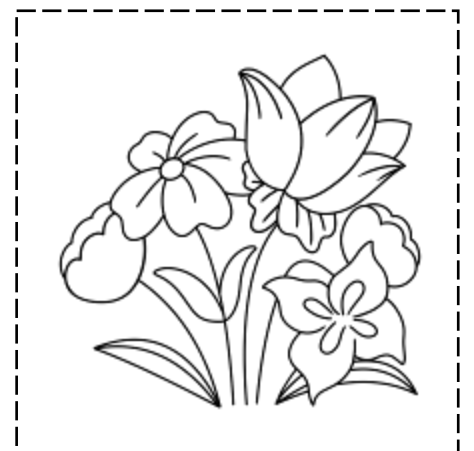
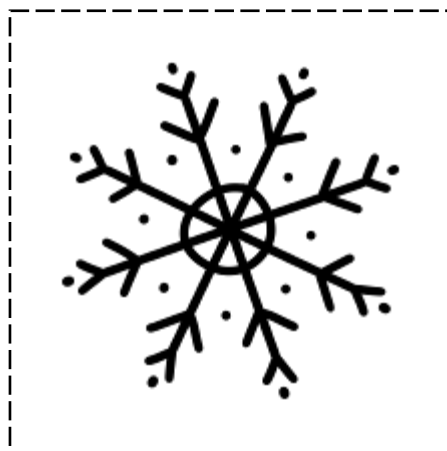
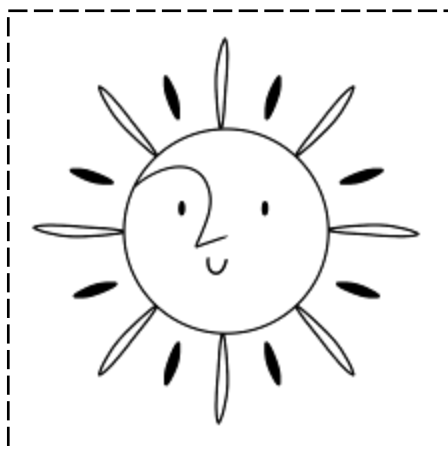



Understanding sentences

Kindergarten Sentences Worksheet

Read each sentence.

Cut and paste the pictures below the matching sentences.

I brush my own hair.	We brush our teeth every day.	I make my bed after I wake up.

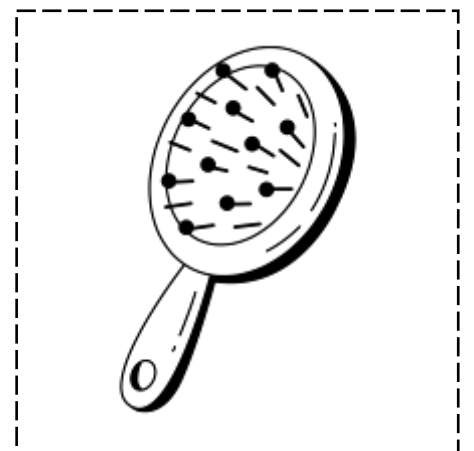
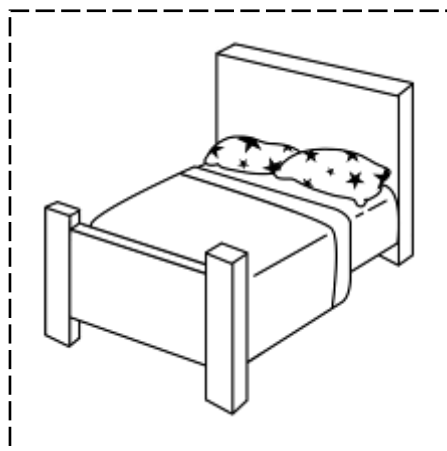
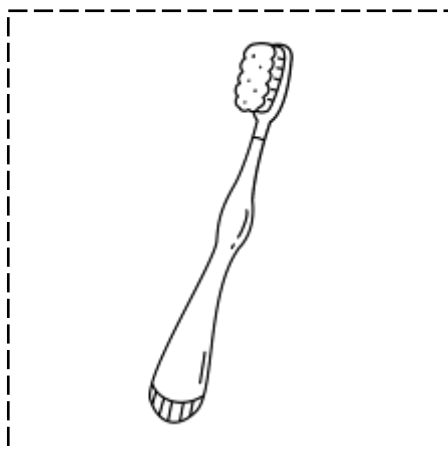



Sentence tracing and comprehension

Kindergarten Sentences Worksheet

First, trace each sentence. Next, read each aloud.

Then, draw a line to match the sentence to the correct picture.

I plug in the cord.

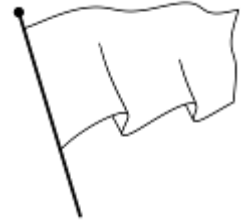

The flag waves high.



We clap after the play.

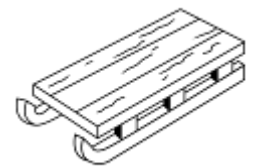

The sled moves fast!





Sentence tracing and comprehension

Kindergarten Sentences Worksheet

First, trace each sentence. Next, read each aloud.

Then, draw a line to match the sentence to the correct picture.

The snail moves slow.

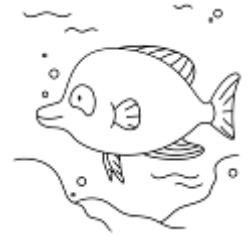

A snake moves in the grass.



Look at the fish swim.



A spider spins a web.





Sentence tracing and comprehension

Kindergarten Sentences Worksheet

First, trace each sentence. Next, read each aloud.

Then, draw a line to match the sentence to the correct picture.

Look at the fuzzy chick!



Did you eat a bag of chips?



Go sit in that chair.



I like to eat cheese.

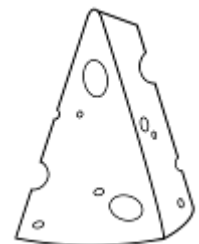



Sentence tracing and comprehension

Kindergarten Sentences Worksheet

First, trace each sentence. Next, read each aloud.

Then, draw a line to match the sentence to the correct picture.

My dog is brown.

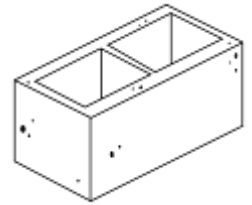

I brush my long hair.



Do you like to eat
bread?



This brick is red.





Sentence Unscramble

Kindergarten Sentences Worksheet

Cut and paste each section in the correct order.

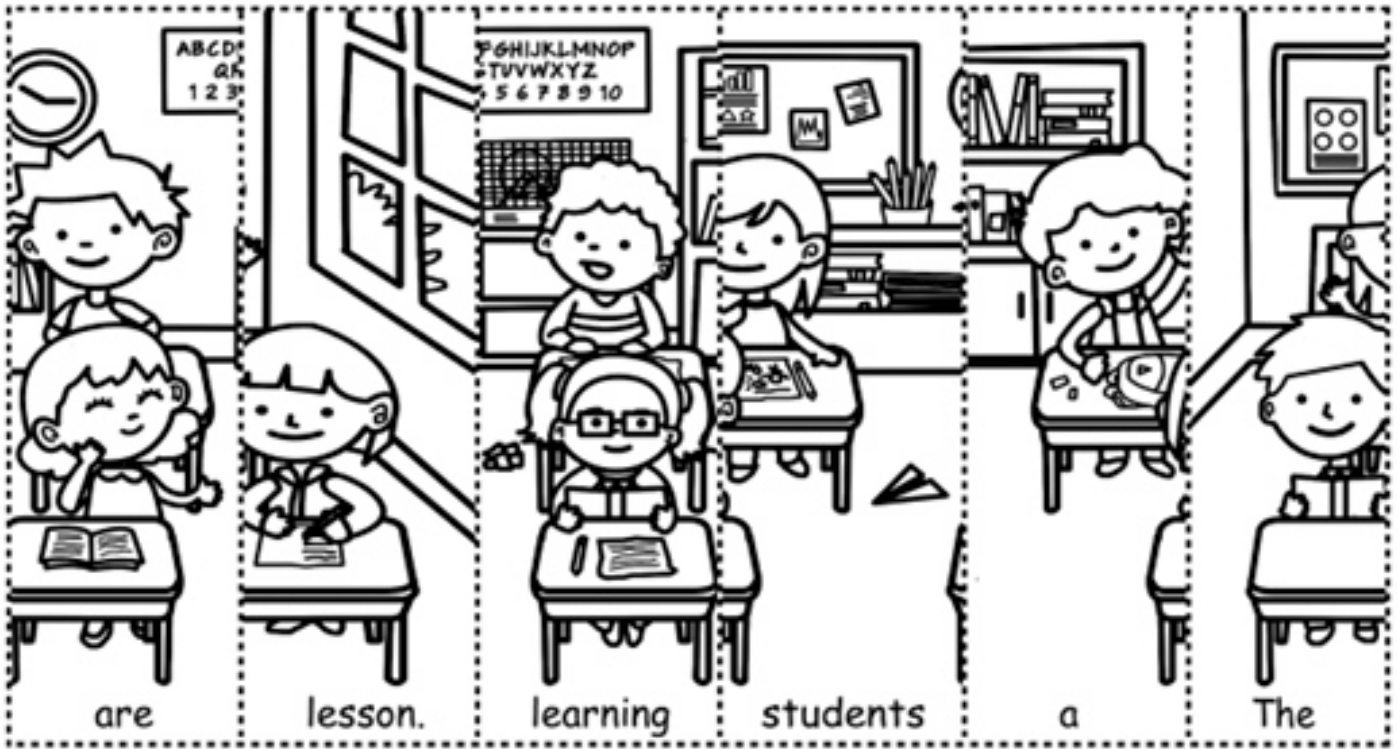

--	--	--	--	--	--



Sentence Unscramble

Kindergarten Sentences Worksheet

Cut and paste each section in the correct order.

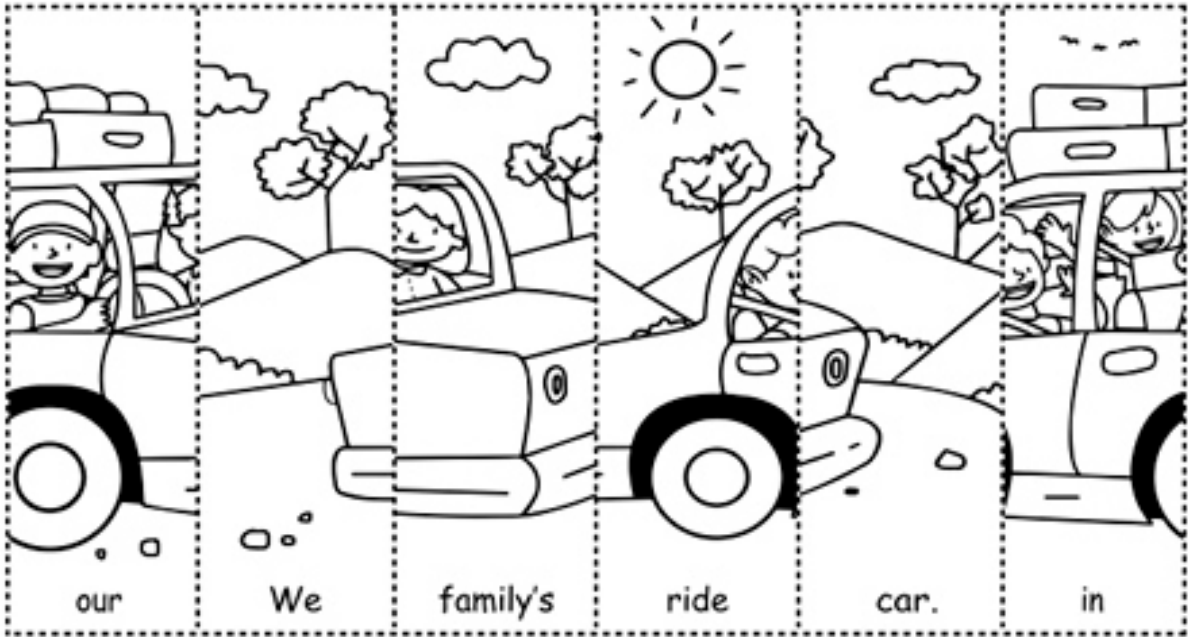

--	--	--	--	--	--



Sentence Unscramble

Kindergarten Sentences Worksheet

Cut and paste each section in the correct order.

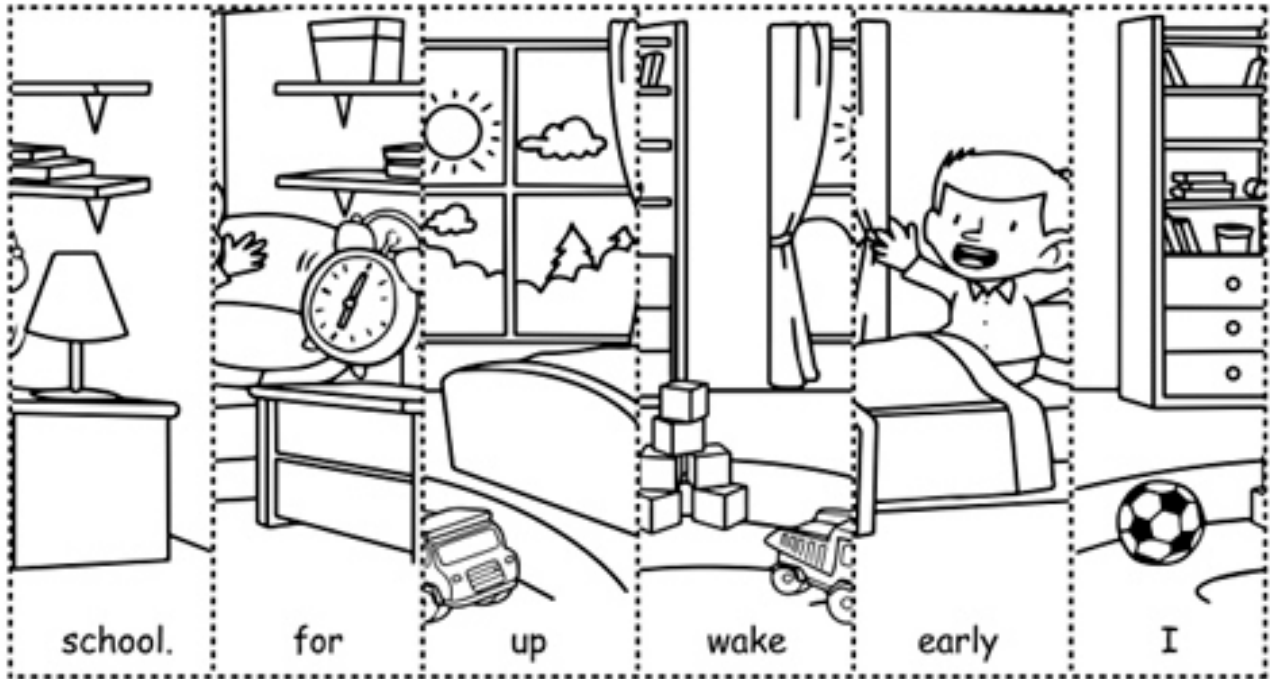

--	--	--	--	--	--



Sentence Unscramble

Kindergarten Sentences Worksheet

Cut and paste each section in the correct order.

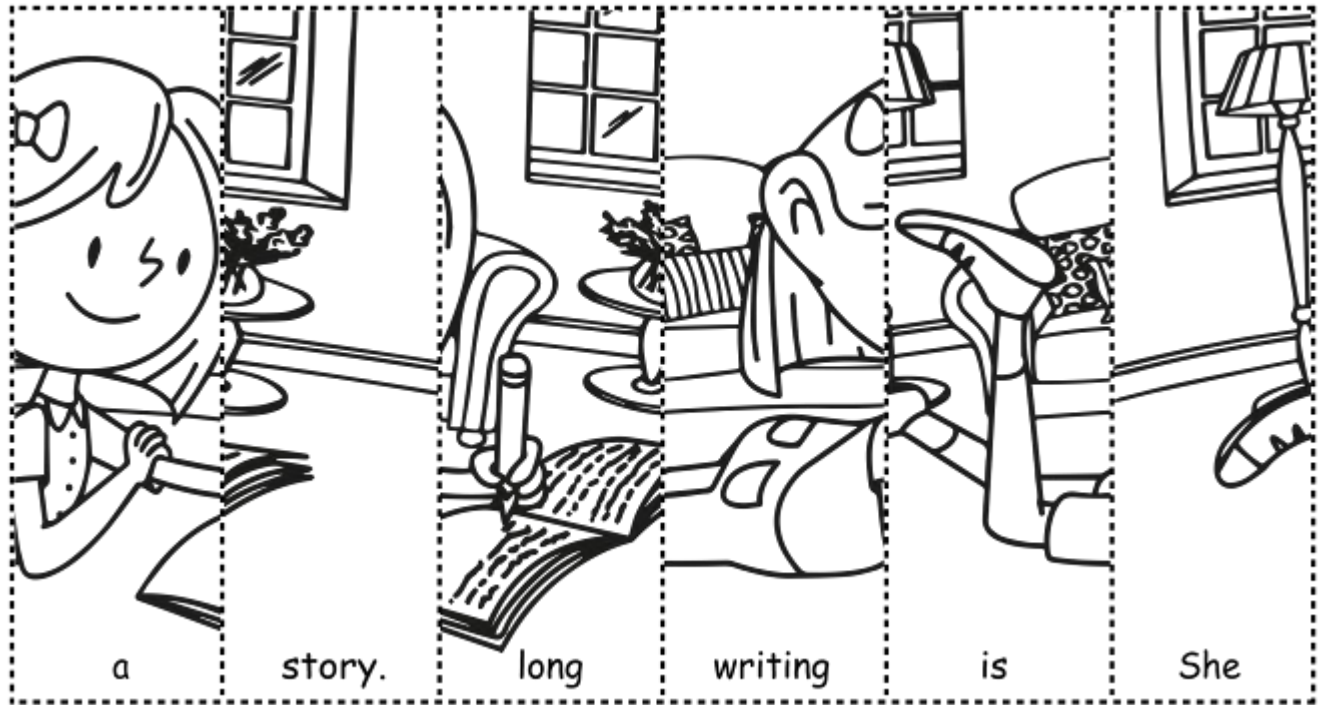

--	--	--	--	--	--



Completing sentences using picture clues

Kindergarten Reading Comprehension Worksheet

Write the last word in each sentence. Use the picture as a clue.

I see the

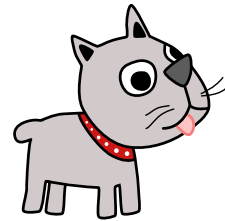

coat
cat

I see the



stamp
stew

I see the

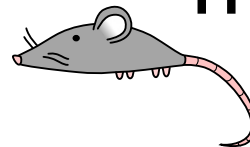

mouse
mat

I see the



chin
chair

I see the

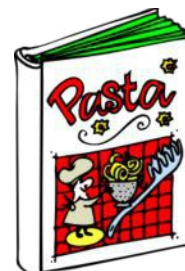

boy
book



Completing sentences using picture clues

Kindergarten Reading Comprehension Worksheet

Write the last word in each sentence. Use the picture as a clue.

I see the



man
moon

I see the



tower
towel

I see the

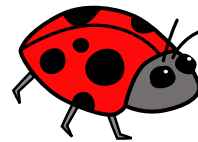

bush
bug

I see the



pot
pole

I see the



door
dish



Completing sentences using picture clues

Kindergarten Reading Comprehension Worksheet

Write the last word in each sentence. Use the picture as a clue.

I see the



deer
door

I see the



fog
frog

I see the

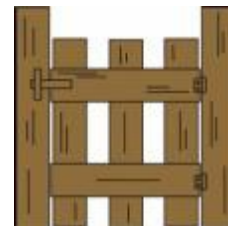

grate
gate

I see the



hat
ham

I see the



plate
pail



Completing sentences using picture clues

Kindergarten Reading Comprehension Worksheet

Write the last word in each sentence. Use the picture as a clue.

I see the



zebra
zany

I see the



queen
quilt

I see the



marble
market

I see the

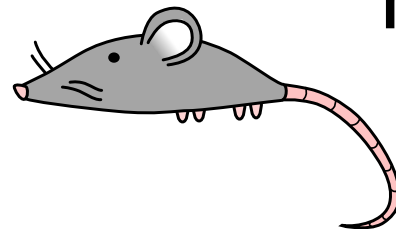

rag
rat

I see the



iron
igloo



Illustrating sentences

Kindergarten Sentences Worksheet

Read each sentence aloud.

In the box, draw a picture to go with that sentence.

The fish can swim.

I have cake on my dish.

Shh, the baby is sleeping.

I can tie my own shoe.



Illustrating sentences

Kindergarten Sentences Worksheet

Read each sentence aloud.

In the box, draw a picture to go with that sentence.

I chomp and chew my food.

We cheer for the team!

He chops down the tree.

I eat chips in my chair.



Illustrating sentences

Kindergarten Sentences Worksheet

Read each sentence aloud.

In the box, draw a picture to go with that sentence.

My candy is cherry.

The baby will cry very much.

Try to dry the toy.

Roy's plane will fly in the sky.



Illustrating sentences

Kindergarten Sentences Worksheet

Read each sentence aloud.

In the box, draw a picture to go with that sentence.

Thank you for the hat.

That path is thin and long.

I think it is time for a bath.

The math book is thick.



Reading fluency

Kindergarten Sentences Worksheet

Read each line.

Rewrite the sentence on the line. Answer the questions.

The

The bird

The bird flies

The bird flies in

The bird flies in the

The bird flies in the sky.



Handwriting practice lines consisting of two sets of three horizontal lines each: a solid blue top line, a dashed red middle line, and a solid blue bottom line.

Who flies? a. The fish b. The bug c. The bird	Where do they fly? a. The sky b. The sea c. The land
--	---



Reading fluency

Kindergarten Sentences Worksheet

Read each line.

Rewrite the sentence on the line. Answer the questions.

My

My sister

My sister can

My sister can jump

My sister can jump so

My sister can jump so high!



Handwriting practice lines consisting of two sets of three horizontal lines each: a solid blue top line, a dashed red middle line, and a solid blue bottom line.

Who can jump?

- a. My sister
- b. My brother
- c. My mother

She can jump _____.

- a. fast
- b. high
- c. slow



Reading fluency

Kindergarten Sentences Worksheet

Read each line.

Rewrite the sentence on the line. Answer the questions.

Cars

Cars go

Cars go fast

Cars go fast down

Cars go fast down the

Cars go fast down the street.



Handwriting practice lines consisting of two sets of three horizontal lines each: a solid blue top line, a dashed red middle line, and a solid blue bottom line.

What can go?

- a. cows
- b. cats
- c. cars

Cars go _____.

- a. fast
- b. high
- c. slow



Reading fluency

Kindergarten Sentences Worksheet

Read each line.

Rewrite the sentence on the line. Answer the questions.

Small

Small crabs

Small crabs walk

Small crabs walk along

Small crabs walk along the

Small crabs walk along the beach.

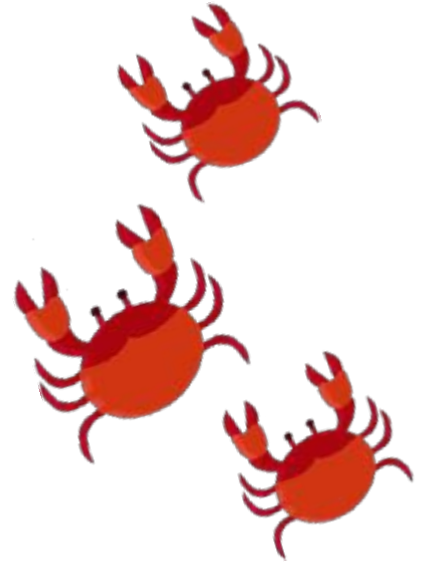

Handwriting practice lines consisting of two sets of blue solid lines with a red dashed midline.

What walks?

a. beaches

b. crabs

c. fish

Crabs walk along _____.

a. the road

b. the beach

c. the lane



Fluency phrases: things that go!

Kindergarten Sentences Worksheet

Read each phrase three times.

Place a checkmark in the box each time you read.



I can go in a car.



I can go on a train.



I can go on a bus.



I can go on a bike.



I can go in a plane.



Fluency phrases: animals at the zoo

Kindergarten Sentences Worksheet

Read each phrase three times.

Place a checkmark in the box each time you read.



At the zoo, we see a gorilla.



At the zoo, we see a panther.



At the zoo, we see a lion.



At the zoo, we see a zebra.



At the zoo, we see a tiger.



Fluency phrases: school days

Kindergarten Sentences Worksheet

Read each phrase three times.

Place a checkmark in the box each time you read.



There are students at school.



There are teachers at school.



There are classrooms at school.



There are pencils at school.



There are books at school.



Fluency phrases: happy campers!

Kindergarten Sentences Worksheet

Read each phrase three times.

Place a checkmark in the box each time you read.



The campers start a fire.



The campers pitch a tent.



The campers hike in the woods.



The campers bring flashlights.



The campers have sleeping bags.



Fluency phrases: sports

Kindergarten Sentences Worksheet

Read each phrase three times.

Place a checkmark in the box each time you read.



The soccer team plays a
game.



The baseball team plays a
game.



The hockey team plays a
game.



The football team plays a
game.



The basketball team plays a
game.



Matching sentences and answers using riddles

Kindergarten Reading Comprehension Worksheet

Read the sentences and write the answer to the riddles.

I am on a table.

I give off light.

What am I?

I have feathers.

I chirp.

What am I?

I am in a kitchen.

I keep things cold.

What am I?



fridge

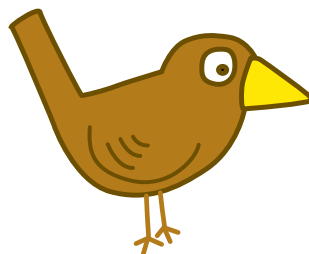

bird

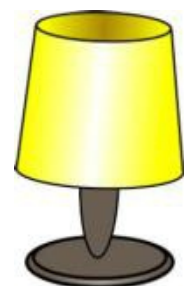

lamp



Matching sentences and answers using riddles

Kindergarten Reading Comprehension Worksheet

Read the sentences and write the answer to the riddles.

I am in the water.
I can be paddled.
What am I?

I am in a bathroom.
I clean your teeth.
What am I?

I am big and yellow.
I take kids to school.
What am I?



bus

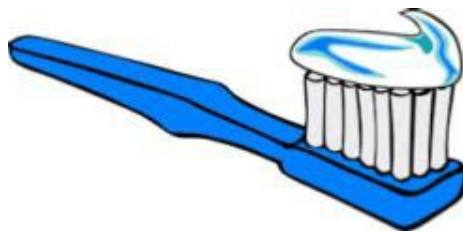

toothbrush



boat



Matching sentences and answers using riddles

Kindergarten Reading Comprehension Worksheet

Read the sentences and write the answer to the riddles.

I am in a frame.

I hang on the wall.

What am I?

I live in a lake.

I swim all around.

What am I?

I am in a bedroom.

I hold clothing.

What am I?

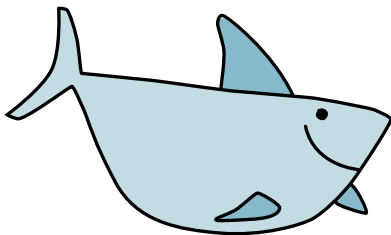

fish



dresser



picture



Matching sentences and answers using riddles

Kindergarten Reading Comprehension Worksheet

Read the sentences and write the answer to the riddles.

I fly in the sky.
I carry many people.
What am I?

I am on a wrist.
I tell time.
What am I?

I am a type of fruit.
I am red and round.
What am I?



airplane



apple



watch



Reading and answering riddles

Kindergarten Reading Comprehension Worksheet

Read the sentences and write the answer to the riddles.

I am in a kitchen.

I cook food.

What am I?

I have leaves.

You can climb me.

What am I?

I have 4 wheels.

I drive on roads.

What am I?

I am on a shelf.

You read me.

What am I?

tree car oven book



Reading and answering riddles

Kindergarten Reading Comprehension Worksheet

Read the sentences and write the answer to the riddles.

I have two wheels.

You can ride me.

What am I?

I fly in the sky.

I am on a string.

What am I?

I live near ponds.

I hop through yards.

What am I?

I am on your desk.

You use me to write.

What am I?

kite bike frog pencil



Reading and answering riddles

Kindergarten Reading Comprehension Worksheet

Read the sentences and write the answer to the riddles.

I help in the yard.

I move leaves.

What am I?

I am round.

You eat me for
breakfast.

What am I?

I have four legs.

You sit on me.

What am I?

I am a large cat.

I live at the zoo.

What am I?

chair pancake tiger rake



Reading and answering riddles

Kindergarten Reading Comprehension Worksheet

Read the sentences and write the answer to the riddles.

You swing me.

I hit baseballs.

What am I?

I spin around.

I represent the earth.

What am I?

I hold food.

You eat off of me.

What am I?

I hold clothing.

I hang in a closet.

What am I?

hanger bat plate globe